



Tumble & Learn Color Mixer™



Parent's Guide

This guide contains important information. Please keep it for future reference.

91-003435-008 (US)

INTRODUCTION

Thank you for purchasing the **Tumble & Learn Color Mixer™**. Watch the cute truck light up and come to life by dropping balls into the mixer and pushing its colorful shape buttons. Push down on the mixer lever to tumble the balls inside and open the door to dump the balls out. Kids will have a blast while building their knowledge of numbers, shapes and colors.

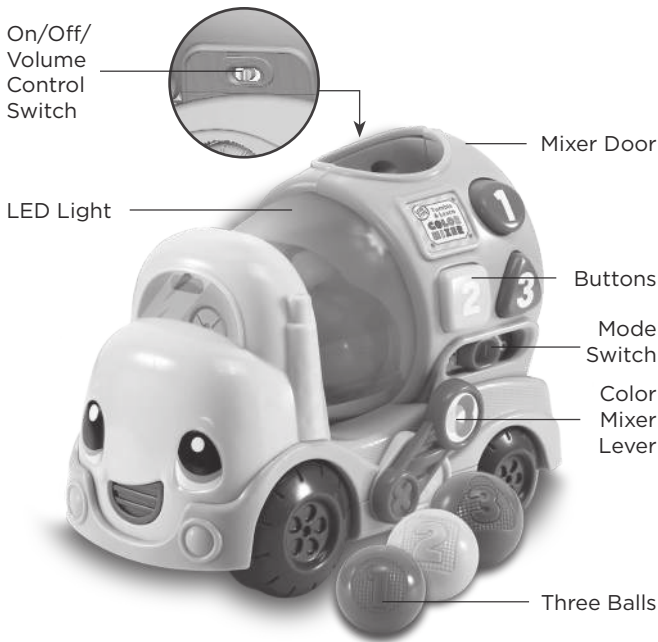

INCLUDED IN THIS PACKAGE

- One Tumble & Learn Color Mixer™
- Three balls
- One parent's guide

WARNING:

All packing materials such as tape, plastic sheets, packaging locks, removable tags, cable ties and packaging screws are not part of this toy, and should be discarded for your child's safety.

NOTE:

Please keep this parent's guide as it contains important information.

ATTENTION:

Pour la sécurité de votre enfant, débarrassez-vous de tous les produits d'emballage tels que rubans adhésifs, feuilles de plastique, attaches, étiquettes et vis d'emballage. Ils ne font pas partie du jouet.

NOTE:

Il est conseillé de conserver ce guide des parents car il comporte des informations importantes.

Unlock the packaging locks:

- ① Rotate the packaging locks 90 degrees counterclockwise.
- ② Pull out the packaging locks and discard.

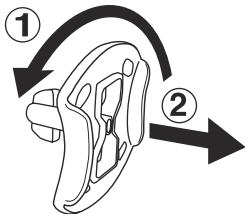

ACTIVATE NORMAL PLAY MODE

This product is in try-me mode in the packaging. To activate normal play mode, please complete the following steps:

1. Slide the **On/Off/Volume Control Switch** to the **OFF (●)** position.
2. Slide the **On/Off/Volume Control Switch** to the **Low or High Volume Control (⏮/⏭)** position to activate normal play mode.

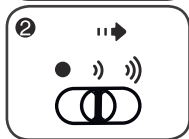
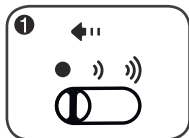

ACTIVATION DU MODE DE JEU NORMAL

Ce produit est en mode Démonstration dans son emballage. Pour activer le mode de jeu Normal, merci d'effectuer les étapes ci-dessous :

1. Glisser le **Curseur Marche/Arrêt/Réglage du volume sonore** sur la position **Arrêt (●)**.
2. Ensuite, glisser le **Curseur Marche/Arrêt/Réglage du volume sonore** sur la position **Volume faible ou Volume fort (⏮/⏭)** pour activer le mode de jeu Normal.

GETTING STARTED

BATTERY INSTALLATION

1. Make sure the unit is turned **OFF**.
2. Locate the battery cover on the bottom of the unit.
3. Use a screwdriver to loosen the screw and open the battery cover.
4. Install 2 new AA (AM-3/LR6) batteries into the battery box as illustrated. (The use of new alkaline batteries is recommended for maximum performance.)
5. Replace the battery cover and tighten the screw to secure.

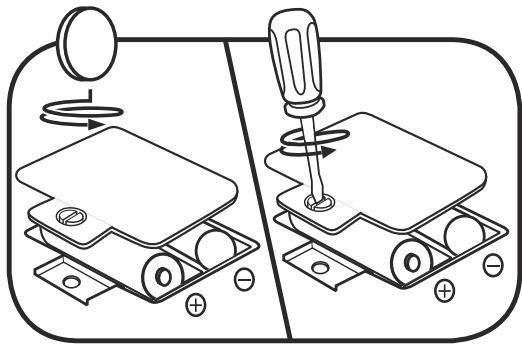

BATTERY NOTICE

- Use new alkaline batteries for maximum performance.
- Use only batteries of the same or equivalent type as recommended.
- Do not mix different types of batteries: alkaline, standard (carbon-zinc) or rechargeable, or new and used batteries.
- Do not use damaged batteries.
- Insert batteries with the correct polarity.
- Do not short-circuit the battery terminals.
- Remove exhausted batteries from the toy.
- Remove batteries during long periods of non-use.
- Do not dispose of batteries in fire.
- Do not charge non-rechargeable batteries.
- Remove rechargeable batteries from the toy before charging (if removable).
- Rechargeable batteries are only to be charged under adult supervision.

MISE EN GARDE

- Utiliser des piles alcalines neuves pour des performances maximales.
- Seules des piles du type recommandé doivent être utilisées.
- Ne pas mélanger différents types de piles ou d'accumulateurs, ne pas mélanger des piles ou des accumulateurs neufs avec des usagés.
- Ne pas utiliser des piles ou des accumulateurs endommagés.
- Mettre en place les piles ou les accumulateurs en respectant les polarités + et -.
- Ne pas mettre les bornes d'une pile ou d'un accumulateur en court-circuit (en reliant directement le + et le -).
- Enlever les piles ou les accumulateurs usagés du jouet.
- Retirer les piles ou les accumulateurs en cas de non-utilisation prolongée.
- Ne les jeter ni au feu ni dans la nature.
- Ne pas tenter de recharger des piles non rechargeables.
- Enlever les accumulateurs du jouet pour les recharger.
- Les accumulateurs ne doivent être chargés que sous la surveillance d'un adulte.

PRODUCT FEATURES

1. On/Off/Volume Control Switch

Slide the **On/Off/Volume Control Switch** to turn the toy on and select the volume.



2. Buttons

Press to hear cool truck sounds and fun phrases that introduce numbers, shapes and colors.



3. Mode Switch

Slide the **Mode Switch** to choose Music Mixer, Training Time or Let's Get to Work mode.



4. Color Mixer Lever

Push down to activate the mixer.



5. Color Mixing Balls

Drop the balls into the mixer to hear fun phrases and sound effects. Drop two balls in and press the **Color Mixer Lever** to "mix" the colors together.



ACTIVITIES

1. Music Mixer

Drop balls into the mixer to play music. Layer construction sounds over the music by pressing the **Buttons**. Press the **Color Mixer Lever** to tumble balls, create new colors and make cool beats! Open the **Mixer Door** to stop the music and sound effects.



2. Training Time

Drop balls into the mixer to hear their colors or numbers announced. The mixer will light up with a matching color. Press the **Color Mixer Lever** to tumble the balls and mix the colors. Open the **Mixer Door** to retrieve the balls. Press the **Buttons** to hear number, shape and color phrases.

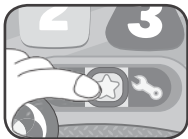

3. Let's Get to Work

Answer questions by pressing the **Buttons** or by dropping balls into the mixer.

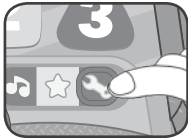

CARE & MAINTENANCE

1. Keep the unit clean by wiping it with a slightly damp cloth.
2. Keep the unit out of direct sunlight and away from any direct heat sources.
3. Remove the batteries when the unit is not in use for an extended period of time.
4. Do not drop the unit on a hard surface and do not expose the unit to excess moisture.

TROUBLESHOOTING

If for some reason the program/activity stops working, please follow these steps:

1. Turn the unit **OFF**.
2. Interrupt the power supply by removing the batteries.
3. Let the unit stand for a few minutes, then replace the batteries.
4. Turn the unit back **ON**. The unit will now be ready to play again.
5. If the unit still does not work, replace with an entire set of new batteries.

Environmental phenomena.

The unit may malfunction if subjected to radio-frequency interference. It should revert to normal operation when the interference stops. If not, it may become necessary to turn the power **OFF** and back **ON**, or remove and reinstall the batteries. In the unlikely event of an electrostatic discharge, the unit may malfunction and lose memory, requiring the user to reset the device by removing and reinstalling the batteries.

Impact de l'environnement.

Une défaillance de fonctionnement de l'appareil peut survenir s'il est sujet à des interférences avec les fréquences radioélectriques. Le fonctionnement normal de l'appareil devrait reprendre avec l'arrêt des interférences. Si ce n'est pas le cas, il peut s'avérer nécessaire d'éteindre et rallumer l'appareil ou de retirer et réinstaller les piles. Dans l'éventualité peu probable d'une décharge électrostatique, un mauvais fonctionnement et une perte de mémoire de l'appareil peuvent se produire. L'utilisateur doit alors retirer et réinstaller les piles pour réinitialiser l'appareil.

IMPORTANT NOTE:

If the problem persists, please call our Consumer Services Department at **1-800-701-5327** in the U.S. or email support@leapfrog.com. Creating and developing LeapFrog® products is accompanied by a responsibility that we take very seriously. We make every effort to ensure the accuracy of the information, which forms the value of our products. However, errors sometimes can occur. It is important for you to know that we stand behind our products and encourage you to contact us with any problems and/or suggestions you might have. A service representative will be happy to help you.

NOTE:

This equipment has been tested and found to comply with the limits for a Class B digital device, pursuant to Part 15 of the FCC Rules. These limits are designed to provide reasonable protection against harmful interference in a residential installation. This equipment generates, uses and can radiate radio frequency energy and, if not installed and used in accordance with the instructions, may cause harmful interference to radio communications. However, there is no guarantee that interference will not occur in a particular installation. If this equipment does cause harmful interference to radio or television reception, which can be determined by turning the equipment off and on, the user is encouraged to try to correct the interference by one or more of the following measures:

- Reorient or relocate the receiving antenna.
- Increase the separation between the equipment and receiver.
- Connect the equipment into an outlet on a circuit different from that to which the receiver is connected.
- Consult the dealer or an experienced radio/TV technician for help.

THIS DEVICE COMPLIES WITH PART 15 OF THE FCC RULES. OPERATION IS SUBJECT TO THE FOLLOWING TWO CONDITIONS: (1) THIS DEVICE MAY NOT CAUSE HARMFUL INTERFERENCE, AND (2) THIS DEVICE MUST ACCEPT ANY INTERFERENCE RECEIVED, INCLUDING INTERFERENCE THAT MAY CAUSE UNDESIRE OPERATION.

CAN ICES-3 (B)/NMB-3(B)

Caution: Changes or modifications not expressly approved by the party responsible for compliance could void the user's authority to operate the equipment.



**CLASS 1
LED PRODUCT**

***Read our complete warranty policy
online at
leapfrog.com/warranty.***



*Visit our website for more
information about our products,
downloads, resources and more.*

leapfrog.com