



# Smart Sizzlin' BBQ Grill™



## Parent's Guide

This guide contains important information. Please keep it for future reference.

91-003711-000 (US)

# INTRODUCTION

Thank you for purchasing the **Smart Sizzlin' BBQ Grill™!** This friendly grill features pretend temperature controls, a skewer and 16 play pieces, including play food, sauce, utensils and dishes. Attach the food pieces to the skewer, and the grill will recognize each piece while introducing food and colors. Turn the skewer to count along from 1-10. Turn the temperature dial to hear fun sounds and see the grill lighting effects. Press the Star button to hear what food the BBQ wants to cook. Ready, set, grill!

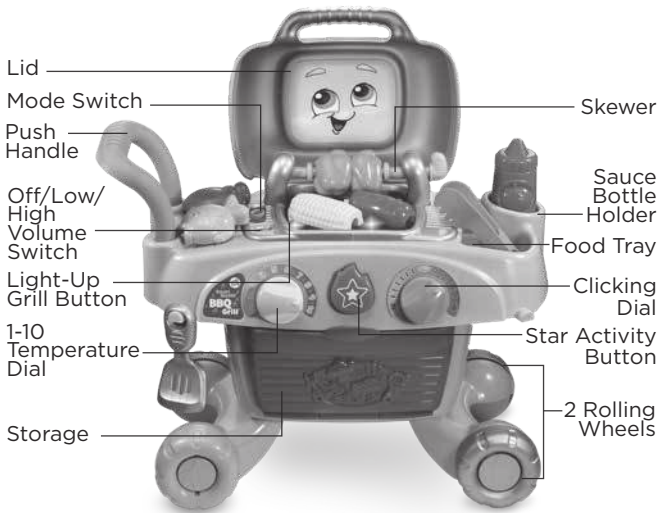

# INCLUDED IN THIS PACKAGE



One Smart Sizzlin'  
BBQ Grill™



One red hot dog



One blue fish



One set of four  
orange shrimp



One brown steak



One purple  
eggplant



One pair of green  
peppers



One set of three  
white mushrooms



One yellow corn



One bun



One sauce bottle



One pair of tongs



One spatula



Two plates



Two forks

- One parent's guide

**WARNING:**

All packing materials such as tape, plastic sheets, packaging locks, removable tags, cable ties and packaging screws are not part of this toy, and should be discarded for your child's safety.

**NOTE:**

Please keep this parent's guide as it contains important information.

**ATTENTION :**

Pour la sécurité de votre enfant, débarrassez-vous de tous les produits d'emballage tels que rubans adhésifs, feuilles de plastique, attaches, étiquettes et vis d'emballage. Ils ne font pas partie du jouet.

**NOTE :**

Il est conseillé de conserver ce guide des parents car il comporte des informations importantes.

# GETTING STARTED

## BATTERY INSTALLATION

1. Make sure the unit is turned **OFF**.
2. Locate the battery cover on the bottom of the unit.
3. Use a screwdriver to loosen the screw and open the battery cover.
4. Install 2 new AA (AM-3/LR6) batteries into the battery box as illustrated. (The use of new alkaline batteries is recommended for maximum performance.)
5. Replace the battery cover and tighten the screw to secure.

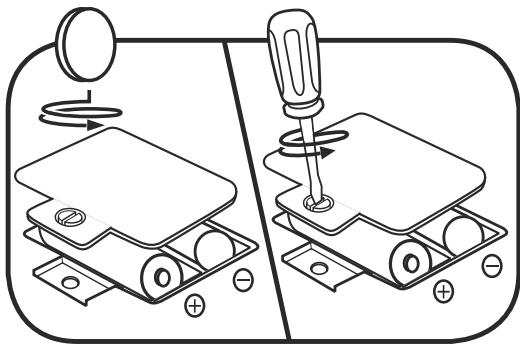

## **BATTERY NOTICE**

- Use new alkaline batteries for maximum performance.
- Use only batteries of the same or equivalent type as recommended.
- Do not mix different types of batteries: alkaline, standard (carbon-zinc) or rechargeable, or new and used batteries.
- Do not use damaged batteries.
- Insert batteries with the correct polarity.
- Do not short-circuit the battery terminals.
- Remove exhausted batteries from the toy.
- Remove batteries during long periods of non-use.
- Do not dispose of batteries in fire.
- Do not charge non-rechargeable batteries.
- Remove rechargeable batteries from the toy before charging (if removable).
- Rechargeable batteries are only to be charged under adult supervision.

## **MISE EN GARDE**

- Utiliser des piles alcalines neuves pour des performances maximales.
- Seules des piles du type recommandé doivent être utilisées.
- Ne pas mélanger différents types de piles ou d'accumulateurs, ne pas mélanger des piles ou des accumulateurs neufs avec des usagés.
- Ne pas utiliser des piles ou des accumulateurs endommagés.
- Mettre en place les piles ou les accumulateurs en respectant les polarités + et -.
- Ne pas mettre les bornes d'une pile ou d'un accumulateur en court-circuit (en reliant directement le + et le -).
- Enlever les piles ou les accumulateurs usagés du jouet.
- Retirer les piles ou les accumulateurs en cas de non-utilisation prolongée.
- Ne les jeter ni au feu ni dans la nature.
- Ne pas tenter de recharger des piles non rechargeables.
- Enlever les accumulateurs du jouet pour les recharger.
- Les accumulateurs ne doivent être chargés que sous la surveillance d'un adulte.

# ASSEMBLY

Safety comes first with the **Smart Sizzlin' BBQ Grill™**. To ensure your child's safety, adult assembly is required. After assembling the BBQ Grill, most of the unit cannot be disassembled. (As indicated below in steps 1 and 4, the lid and storage area can be removed and re-attached. All other steps will be permanent after assembled.)

1. Insert the **Lid** into the top of the **BBQ Grill**. (Note: If the lid is removed, follow this step to re-install.)

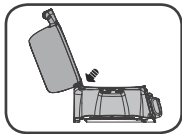

2. Insert the **Handle** next to the **Lid**.

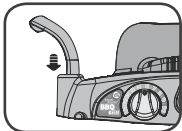

3. Insert the storage area onto the bottom of the **BBQ Grill**.

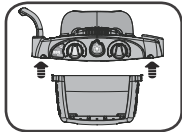

4. Insert the storage door onto the storage area. (Note: If the door is removed, follow this step to re-install.)

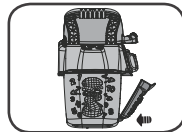

5. Attach the left wheels onto the bottom of the storage area.

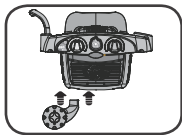

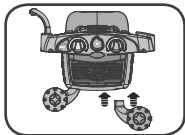

6. Attach the right **Rolling Wheels** onto the bottom of the storage area.



## PRODUCT FEATURES

### 1. Off/Low/High Volume Switch

To turn the unit **On**, slide the **Off/Low/High Volume** switch to the **Low Volume**  or the **High Volume**  position. To turn the unit **Off**, slide the **Off/Low/High Volume** switch to the **Off**  position.



### 2. Mode Switch

Move the **Mode** switch to any position to play one of three modes: Learn mode, Play mode and Music mode.



### 3. Lid

Open and close the **Lid** to hear greetings or sing along to a song.





#### 4. Skewer

Put a food play piece on the **Skewer** to learn its color and name or turn the **Skewer** to count along and pretend to cook the food.



#### 5. Light-Up Grill Button

Press the **Light-Up Grill** button to hear fun flame and sizzling sounds as the grill lights up.



#### 6. 1-10 Temperature Dial

Turn the 1-10 **Temperature Dial** to set the temperature on the grill, learn numbers 1-10 and watch how the grill lights up. In Music mode, each dial position plays a different tune.



#### 7. Star Activity Button

In Learn mode, press the **Star Activity** button to hear what the BBQ wants to cook next and follow along. In Play mode, press the **Star Activity** button to hear fun phrases and sounds, sing-along songs, and a rhyme about the food on the **Skewer**.



## 8. Clicking Dial

Turn the **Clicking Dial** to practice fine motor skills and hear a clicking sound.



# ACTIVITIES

## 1. Learn Mode

Move the **Mode** switch to Learn mode and learn food names, colors and numbers while pretending to grill foods or practice listening comprehension.



## 2. Play Mode

Move the **Mode** switch to Play mode to hear fun rhymes and pretend to grill foods with suggested ways to play.



## 3. Music Mode

Move the **Mode** switch to Music mode, and turn the 1-10 **Temperature Dial** to choose a tune to play. Press any of the buttons or put a food on the skewer to jam along to the tune.



## CARE & MAINTENANCE

1. Keep the unit clean by wiping it with a slightly damp cloth.
2. Keep the unit out of direct sunlight and away from any direct heat sources.
3. Remove the batteries when the unit is not in use for an extended period of time.
4. Do not drop the unit on a hard surface and do not expose the unit to excess moisture.

## TROUBLESHOOTING

If for some reason the program or activity stops working, please follow these steps:

1. Turn the unit **OFF**.
2. Interrupt the power supply by removing the batteries.
3. Let the unit stand for a few minutes, then replace the batteries.
4. Turn the unit back **ON**. The unit will now be ready to play again.
5. If the unit still does not work, replace with an entire set of new batteries.

## Environmental Phenomena

The unit may malfunction if subjected to radio-frequency interference. It should revert to normal operation when the interference stops. If not, it may become necessary to turn the power **OFF** and back **ON**, or remove and reinstall the batteries. In the unlikely event of an electrostatic discharge, the unit may malfunction and lose memory, requiring the user to reset the device by removing and reinstalling the batteries.

## Impact de l'environnement

Une défaillance de fonctionnement de l'appareil peut survenir s'il est sujet à des interférences avec les fréquences radioélectriques. Le fonctionnement normal de l'appareil devrait reprendre avec l'arrêt des interférences. Si ce n'est pas le cas, il peut s'avérer nécessaire d'éteindre et rallumer l'appareil ou de retirer et réinstaller les piles. Dans l'éventualité peu probable d'une décharge électrostatique, un mauvais fonctionnement et une perte de mémoire de l'appareil peuvent se produire. L'utilisateur doit alors retirer et réinstaller les piles pour réinitialiser l'appareil.

### Supplier's Declaration of Conformity

Trade Name:	LeapFrog®
Model:	6079
Product name:	Smart Sizzlin' BBQ Grill™
Responsible Party:	LeapFrog Enterprises, Inc.
Address:	6401 Hollis Street, Suite 100, Emeryville, CA 94608
Website:	leapfrog.com

THIS DEVICE COMPLIES WITH PART 15 OF THE FCC RULES. OPERATION IS SUBJECT TO THE FOLLOWING TWO CONDITIONS: (1) THIS DEVICE MAY NOT CAUSE HARMFUL INTERFERENCE, AND (2) THIS DEVICE MUST ACCEPT ANY INTERFERENCE RECEIVED, INCLUDING INTERFERENCE THAT MAY CAUSE UNDESIRED OPERATION.

***CAN ICES-3 (B)/NMB-3(B)***

**IMPORTANT NOTE:**

If the problem persists, please call our Consumer Services Department at **1-800-701-5327** in the U.S. or email [support@leapfrog.com](mailto:support@leapfrog.com). Creating and developing LeapFrog® products is accompanied by a responsibility that we take very seriously. We make every effort to ensure the accuracy of the information, which forms the value of our products. However, errors sometimes can occur. It is important for you to know that we stand behind our products and encourage you to contact us with any problems and/or suggestions you might have. A service representative will be happy to help you.

**NOTE:**

This equipment has been tested and found to comply with the limits for a Class B digital device, pursuant to Part 15 of the FCC Rules. These limits are designed to provide reasonable protection against harmful interference in a residential installation. This equipment generates, uses and can radiate radio frequency energy and, if not installed and used in accordance with the instructions, may cause harmful interference to radio communications. However, there is no guarantee that interference will not occur in a particular installation. If this equipment does cause harmful interference to radio or television reception, which can be determined by turning the equipment off and on, the user is encouraged to try to correct the interference by one or more of the following measures:

- Reorient or relocate the receiving antenna.
- Increase the separation between the equipment and receiver.
- Connect the equipment into an outlet on a circuit different from that to which the receiver is connected.
- Consult the dealer or an experienced radio/TV technician for help.

**Caution:** Changes or modifications not expressly approved by the party responsible for compliance could void the user's authority to operate the equipment.



CLASS 1  
LED PRODUCT

***Read our complete warranty policy online  
at [leapfrog.com/warranty](http://leapfrog.com/warranty)***

LeapFrog Enterprises, Inc.,  
A subsidiary of VTech Holdings Limited.  
TM & © 2019 LeapFrog Enterprises, Inc.  
All rights reserved.



*Visit our website for more  
information about our products,  
downloads, resources and more.*

*[leapfrog.com](http://leapfrog.com)*