



Safari Learning Station™



Parent's Guide

This guide contains important information. Please keep it for future reference.

91-003546-000 US

INTRODUCTION

Thank you for purchasing the LeapFrog Safari Learning Station. This toy can be configured for seated play or set up for crawling and standing play. Three modes of learning encourage your child to explore first words, numbers, shapes, colors, animals, music play, Spanish words and more. Physical features including a ball drop, hanging leaves, spinning dial, and bead spinner encourage your child to exercise their developing motor skills.

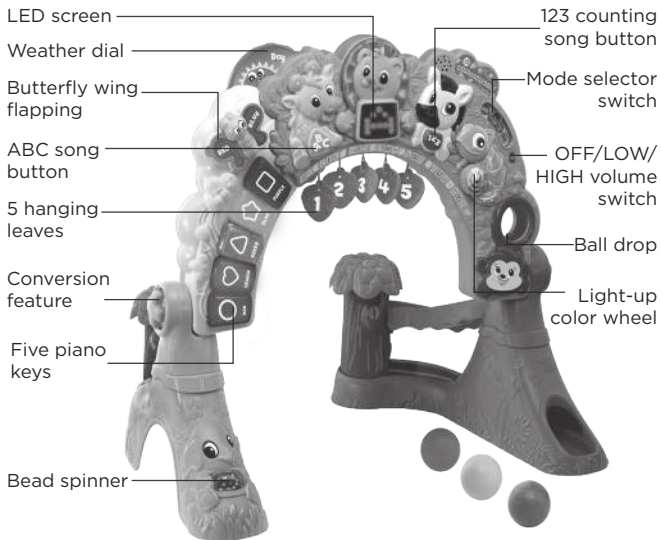

INCLUDED IN THIS PACKAGE

- One LeapFrog Safari Learning Station™
- 3 balls
- One LeapFrog Safari Learning Station™ instruction manual

WARNING:

All packing materials, such as tape, plastic sheets, packaging locks, removable tags, cable ties and packaging screws are not part of this toy, and should be discarded for your child's safety.

NOTE:

Please keep this parent's guide as it contains important information.

ATTENTION:

Pour la sécurité de votre enfant, débarrassez-vous de tous les produits d'emballage tels que rubans adhésifs, feuilles de plastique, attaches, étiquettes et vis d'emballage. Ils ne font pas partie du jouet.

NOTE:

- Il est conseillé de conserver ce guide des parents car il comporte des informations importantes.

Unlock the packaging locks:

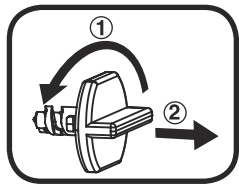

- ① Rotate the packaging lock 90 degrees counter clockwise.
- ② Pull out the packaging lock.

GETTING STARTED

POWER SOURCE

The LeapFrog Safari Learning Station™ operates on 2 AA sized batteries (AM-3/LR6). The AA sized batteries included in the unit are for demo purposes only and are not long-life batteries.

BATTERY INSTALLATION

1. Make sure the unit is turned **OFF**.
2. Locate the battery cover on the bottom of the unit.
3. Use a screwdriver to loosen the screw and open the battery cover.
4. Install 2 new AA (AM-3/LR6) batteries into the battery box as illustrated. (The use of new alkaline batteries is recommended for maximum performance.)
5. Replace the battery cover and tighten the screw to secure.

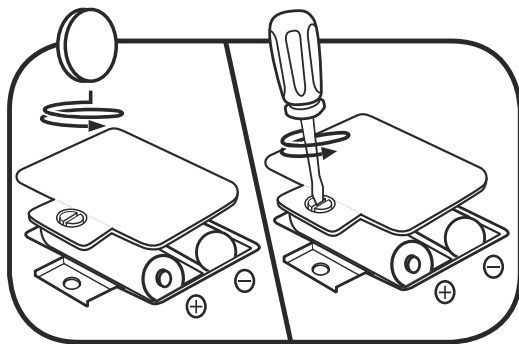

BATTERY NOTICE

- Use new alkaline batteries for maximum performance.
- Use only batteries of the same or equivalent type as recommended.
- Do not mix different types of batteries: alkaline, standard (carbon-zinc) or rechargeable, or new and used batteries.
- Do not use damaged batteries.
- Insert batteries with the correct polarity.
- Do not short-circuit the battery terminals.
- Remove exhausted batteries from the toy.
- Remove batteries during long periods of non-use.
- Do not dispose of batteries in fire.
- Do not charge non-rechargeable batteries.
- Remove rechargeable batteries from the toy before charging (if removable).
- Rechargeable batteries are only to be charged under adult supervision.

MISE EN GARDE

- Utiliser des piles alcalines neuves pour des performances maximales.
- Seules des piles du type recommandé doivent être utilisées.
- Ne pas mélanger différents types de piles ou d'accumulateurs, ne pas mélanger des piles ou des accumulateurs neufs avec des usagés.
- Ne pas utiliser des piles ou des accumulateurs endommagés.
- Mettre en place les piles ou les accumulateurs en respectant les polarités + et -.
- Ne pas mettre les bornes d'une pile ou d'un accumulateur en court-circuit (en reliant directement le + et le -).
- Enlever les piles ou les accumulateurs usagés du jouet.
- Retirer les piles ou les accumulateurs en cas de non-utilisation prolongée.
- Ne les jeter ni au feu ni dans la nature.
- Ne pas tenter de recharger des piles non rechargeables.
- Enlever les accumulateurs du jouet pour les recharger.
- Les accumulateurs ne doivent être chargés que sous la surveillance d'un adulte..

ASSEMBLY

With the **Leapfrog® Safari Learning Station™** safety comes first. To ensure your child's safety, adult assembly is required.

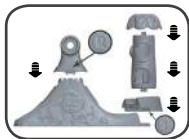

NOTE:

Adjust the desired angle of the Activity Panel, then tighten each leg screw until you hear a “click”. The click signals when the safety lock has been enabled.

PRODUCT FEATURES

1. Conversion feature

Remove the yellow post to swivel the arch up or down to encourage different types of play including seated play, standing play, and crawling play.



2. Off/Low/High Volume Switch

Slide from **OFF** position to either **Low** or **High** to start playing and adjust volume.

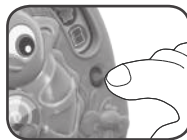

3. 3 Play Modes

Slide the **MODE SWITCH** to select a play mode.

Music Mode: Explore music with safari beats, fun sound effects, and musical play.

Explore Mode: Learn first words

Learn Mode: Learn about shapes, animals, numbers and colors with fun phrases and songs.

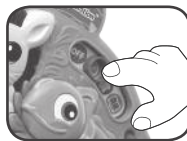

4. ABC song button

Giraffe's ABC button plays a variety of catchy, Safari-themed tunes, including an A-Z learning song



5. 123 counting song button

Zebra's 123 button plays a variety of catchy, Safari-themed tunes, including a 1-20 learning song.



6. LED screen

Press Lion's arrow paws to scroll through letters A to Z, numbers 1 to 20, and shapes including circle, square, and triangle.



7. Color wings

Flip Butterfly's wings to learn about colors including blue, red, green, and purple.

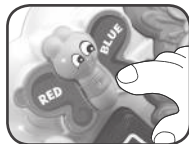

8. Light-up color wheel

Spin Chameleon's tail to see a rainbow light show and hear fun phrases about science and color names.



9. Five piano keys

Press the piano keys to make music and learn about shapes and colors.



10.5 hanging leaves

Pull on the hanging leaves to learn about numbers.



11. Ball drop

Drop balls through Monkey's tail to hear fun sounds and learn about counting.



12. Bead spinner

Spin the colorful bead spinner in Elephant's belly.

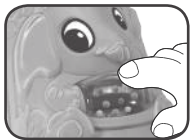

13. Weather dial

Move the weather dial to learn about weather and fun phrases in Spanish.

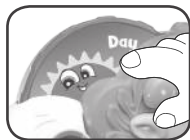

14. AUTOMATIC POWER OFF

To save power, the **LeapFrog Safari Learning Station™** automatically shuts down if it does not have any input after several minutes. Press any button or slide the OFF/LOW/HIGH switch to turn the unit on again.

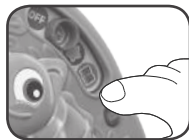

ACTIVITIES

- Activity 1: Explore letters and words with the Giraffe's ABC button and Lion's screen.
- Activity 2: Practice numbers and counting skills with Zebra's 123 button, the hanging leaves, and Lion's screen.
- Activity 3: Engage in creative play with music and colors with Chameleon and the piano keys.
- Activity 4: Stimulate gross and fine motor skills by spinning Elephant's ball roller, dropping balls through Monkey's tail, and crawling under the leaf arch.

CARE & MAINTENANCE

1. Keep the unit clean by wiping it with a slightly damp cloth.
2. Keep the unit out of direct sunlight and away from any direct heat sources.
3. Remove the batteries when the unit is not in use for an extended period of time.
4. Do not drop the unit on a hard surface and do not expose the unit to excess moisture.

TROUBLESHOOTING

If for some reason the program/activity stops working, please follow these steps:

1. Turn the unit **OFF**.
2. Interrupt the power supply by removing the batteries.
3. Let the unit stand for a few minutes, then replace the batteries.
4. Turn the unit back **ON**. The unit will now be ready to play again.
5. If the unit still does not work, replace with an entire set of new batteries.

Environmental phenomena.

The unit may malfunction if subjected to radio-frequency interference. It should revert to normal operation when the interference stops. If not, it may become necessary to turn the power **OFF** and back **ON**, or remove and reinstall the batteries. In the unlikely event of an electrostatic discharge, the unit may malfunction and lose memory, requiring the user to reset the device by removing and reinstalling the batteries.

Impact de l'environnement.

Une défaillance de fonctionnement de l'appareil peut survenir s'il est sujet à des interférences avec les fréquences radioélectriques. Le fonctionnement normal de l'appareil devrait reprendre avec l'arrêt des interférences. Si ce n'est pas le cas, il peut s'avérer nécessaire d'éteindre et rallumer l'appareil ou de retirer et réinstaller les piles. Dans l'éventualité peu probable d'une décharge électrostatique, un mauvais fonctionnement et une perte de mémoire de l'appareil peuvent se produire. L'utilisateur doit alors retirer et réinstaller les piles pour réinitialiser l'appareil.

Supplier's Declaration of Conformity

Trade Name:	Leapfrog®
Model:	6045
Responsible Party:	Leapfrog Enterprises, Inc.
Address:	6401 Hollis Street, Suite 100, Emeryville, CA 94608
Website:	www.leapfrog.com

IMPORTANT NOTE:

If the problem persists, please call our Consumer Services Department at **1-800-701-5327** in the U.S. or email support@leapfrog.com. Creating and developing LeapFrog® products is accompanied by a responsibility that we take very seriously. We make every effort to ensure the accuracy of the information, which forms the value of our products. However, errors sometimes can occur. It is important for you to know that we stand behind our products and encourage you to contact us with any problems and/or suggestions you might have. A service representative will be happy to help you.

NOTE:

This equipment has been tested and found to comply with the limits for a Class B digital device, pursuant to Part 15 of the FCC Rules. These limits are designed to provide reasonable protection against harmful interference in a residential installation. This equipment generates, uses and can radiate radio frequency energy and, if not installed and used in accordance with the instructions, may cause harmful interference to radio communications. However, there is no guarantee that interference will not occur in a particular installation. If this equipment does cause harmful interference to radio or television reception, which can be determined by



turning the equipment off and on, the user is encouraged to try to correct the interference by one or more of the following measures:

- Reorient or relocate the receiving antenna.
- Increase the separation between the equipment and receiver.
- Connect the equipment into an outlet on a circuit different from that to which the receiver is connected.
- Consult the dealer or an experienced radio/TV technician for help.



THIS DEVICE COMPLIES WITH PART 15 OF THE FCC RULES. OPERATION IS SUBJECT TO THE FOLLOWING TWO CONDITIONS: (1) THIS DEVICE MAY NOT CAUSE HARMFUL INTERFERENCE, AND (2) THIS DEVICE MUST ACCEPT ANY INTERFERENCE RECEIVED, INCLUDING INTERFERENCE THAT MAY CAUSE UNDESIRE OPERATION.

CAN ICES-3 (B)/NMB-3(B)



Caution: Changes or modifications not expressly approved by the party responsible for compliance could void the user's authority to operate the equipment.



CLASS 1
LED PRODUCT



*Visit our website for more
information about our products,
downloads, resources and more.*

leapfrog.com

*Read our complete warranty policy
online at
leapfrog.com/warranty.*

LeapFrog Enterprises, Inc.,
a subsidiary of VTech Holdings Limited.
TM & © 2018 LeapFrog Enterprises, Inc.
All rights reserved.
91-003546-000 